

HOBIE KAYAKING & FISHING COLLECTION

# Hobie®



**POWER IN EVERY DIRECTION  
+ NEW KICK-UP FIN TECHNOLOGY**



**1950 FIRST SURFBOARD**

Hobie Alter shapes his first surfboard in his parents' Laguna Beach garage

**1968 HOBIE 14**

A lightweight, beachable catamaran sails into the spotlight

**1970 HOBIE 16**

Classic. The two-person, double trapeze catamaran

**1982 HOBIE 33**

The Hobie 33 was the fastest, sleekest monohull in its class

**1994 HOBIE WAVE**

A user-friendly and minimalistic, rotomolded catamaran

**2001 MIRAGE® OUTBACK**

The Mirage Outback introduced kayak fishing in an SUV package

**2009 MIRAGE PRO ANGLER 14**

Hobie lands a massive strike with a feature-laden fishing boat

**2016 MIRAGEDRIVE 180**

Reverse is added to the legendary MirageDrive

**2019 LAUNCH OF MIRAGEDRIVE 360**

Only Hobie delivers power in every direction for great fishing

**1950**

**1960**

**1970**

**1980**

**1990**

**2000**

**2010**

**2019**

**1954 HOBIE SURF SHOP**

The doors to the first Hobie Surf Shop open in Dana Point, CA

**1958 NEW GENERATION OF SURFING**

Invents Fiberglass/foam-core boards with Grubby Clark

**1982 HOBIE POLARIZED**

Visibility for the best experiences on the water

**1995 HOBIE TRIFOILER**

Drops jaws with its staggering speed

**1997 MIRAGEDRIVE®**

Revolutionizing kayaking forever

**2005 HOBIE SUPS**

Building on 50 years of industry-leading design

**2006 MIRAGE ADVENTURE ISLAND**

The do all trimaran: sail, pedal and paddle

**2016 MIRAGE ECLIPSE**

Hobie makes a splash with the world's first stand-up pedalboard

**2018 NEW MIRAGE OUTBACK**

Introducing the newly redesigned, improved Mirage Outback

# 70 YEARS OF NON-STOP INNOVATION

In 1950, Hobie Alter shaped his first surfboard in his parents' garage in Laguna Beach, California. His visionary designs challenged the limits of watersports and inspired a culture of ingenuity and craftsmanship that lives on today.

From surfboards and world-class catamarans, to revolutionary kayaks and stand-up pedalboards, Hobie is driven by a passion for delivering the most advanced, enjoyable and accessible watersport products available. The Hobie brand continues to be synonymous with leading-edge adventure on the water.

Today, Hobie's passion for the water is built into every kayak we make. Based in Oceanside, CA, Hobie is steadfast in its unwavering commitment to unsurpassed quality, expert craftsmanship and superior performance. 20 years after introducing the original MirageDrive to the world, Hobie remains the most popular and innovative pedal kayak brand on the planet.



# INNOVATION AND INGENUITY. QUALITY AND CRAFTSMANSHIP.

Since Hobie's inception in 1950, these unwavering traits have defined our iconic brand and kept us laser-focused on delivering exhilarating experiences on the water.

As we enter our 70th year, we are thrilled to once-again redefine fun on the water, with evolutionary technological advancements that will enable our customers to experience their passions in dynamic, new ways.

All new for 2020, our team of engineers have revolutionized the Hobie MirageDrive, through two revolutionary patented improvements: the 360 navigation drive system and Kick-Up Fin functionality. These groundbreaking technologies represent the most radical advancements in kayaking since we introduced the original MirageDrive over 20 years ago.

In addition, we've expanded our price-accessible Passport line to include a larger, 12' version. So, whether you are new to pedal kayaking or an elite kayak angler, our fleet of MirageDrive kayaks has you covered.



## MIRAGEDRIVE GUIDE

### POWERED BY MD CLASSIC

The original MirageDrive offers hands-free pedal performance.

MIRAGE PASSPORT 10.5	pg 6
MIRAGE PASSPORT 12	8



### POWERED BY MD GT

MirageDrive with Glide Technology delivers an ultra-smooth ride. New Kick-Up Fin technology.

MIRAGE COMPASS	12
MIRAGE COMPASS DUO	14



### POWERED BY MD 180

Hands-free propulsion in both forward and reverse. New Kick-Up Fin technology.

MIRAGE COMPASS CAMO PACKAGE	12
MIRAGE REVOLUTION SERIES	22
MIRAGE SPORT	24
MIRAGE OASIS	24
MIRAGE OUTBACK	28
MIRAGE PRO ANGLER 12	34
MIRAGE PRO ANGLER 14	36
MIRAGE PRO ANGLER 17T	38
MIRAGE INFLATABLE SERIES	46
MIRAGE ISLAND SERIES	50

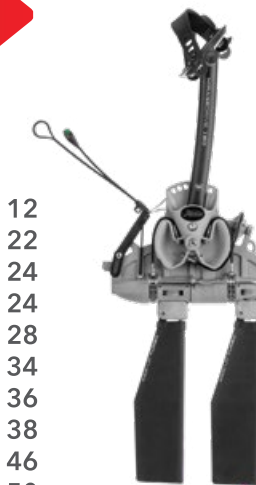

### POWERED BY MD 360

Revolutionary movement in full-circle, 360 degrees. New Kick-Up Fin technology.

MIRAGE PRO ANGLER 12 & 14 with 360 TECH	42
---	----





# MIRAGE PASSPORT 10.5

## YOUR TICKET TO ADVENTURE & FUN

Propelled by the tried-and-true MirageDrive Classic with ST Fins, the Passport 10.5 makes it possible to reach isolated beaches and remote waters, bringing you closer to nature and further from the hustle and bustle.

Every feature is designed with your comfort in mind, starting with an ergonomically designed mesh aluminum frame seat. Sail open water or fish the flats, thanks to the sail-ready vertical accessory mount and molded-in rod holders. Dual mounting tracks keep your accessories within reach while the 8" Twist-n-Seal Hatch will keep them dry. The easy-to-use steering system and simplified version of our twist-and-stow rudder puts navigation at your fingertips and a smile on your face.



Available Colors:



POWERED BY  
MD CLASSIC

Shown with optional  
Sail Kit and Bimini sunshade.







# MIRAGE PASSPORT 12

*NOW IS THE TIME TO GET OUT ON THE WATER*

Introducing the Mirage Passport 12, powered by the original MirageDrive Classic with ST Fins. This 12-foot kayak takes you where you want to go with ease and world-class authority. When you're not relaxing in the Passport's breathable mesh seat, a wider cockpit area with EVA floor padding provides a stable platform for standing and stretching your legs or casting a line. There's plenty of real estate to stash equipment on the bow or stern cargo areas and more below deck access through the center 8" Twist-n-Seal hatch. Anglers will be happy that the Passport 12 has a transducer cavity and scupper for quick install of your favorite fishfinder and a Power-Pole® Micro bracket indent to easily mount your favorite shallow water anchor. Additional features include steering system with stowable rudder, two fishing rod holders, accessory tracks, and under seat and gunnel tackle storage.



Scan code with  
smartphone camera  
for video link

Available Colors:





# MIRAGE PASSPORT

**1** MirageDrive Classic Powered  
Featuring our tried and true, legendary MirageDrive pedal performance.

**2** 8" Twist and Seal Hatch  
Corkscrew closures and hinged lids for in-hull storage.  
*Upgrade to the Rectangular Hatch for more space.\**

**3** Suspended Mesh Aluminum Frame Seat  
Lightweight and comfortable, this breathable mesh seat makes relaxing easy.

**5** Aluminum Two-Piece Paddle  
For added safety and because sometimes it's just too shallow to pedal.

**6** Stowable Rudder  
Deploy when on the water and then stow for easy transport.

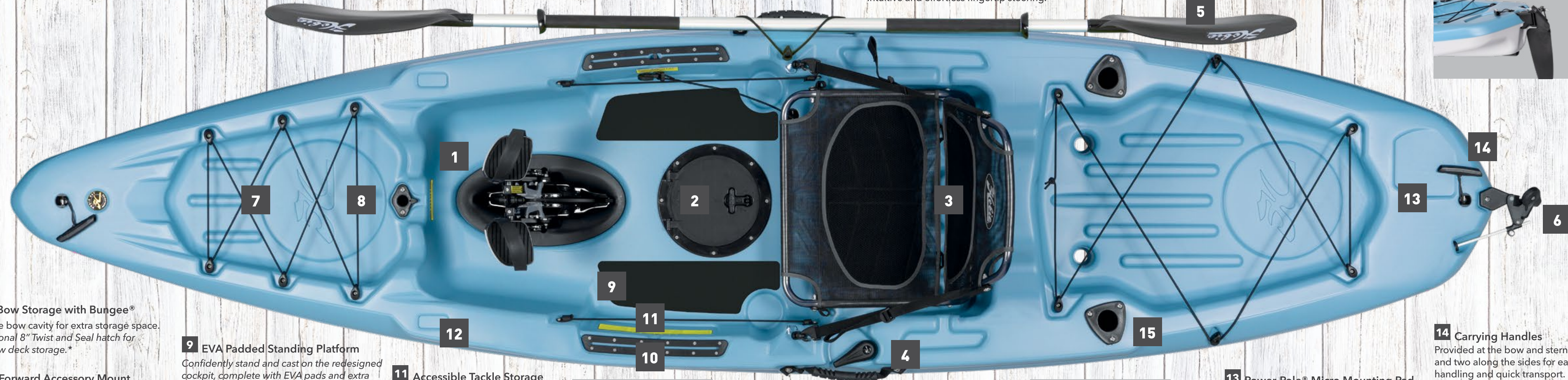

**7** Bow Storage with Bungee®  
Large bow cavity for extra storage space.  
*Optional 8" Twist and Seal hatch for below deck storage.\**

**8** Forward Accessory Mount  
Stands ready for the Hobie Mirage Sail Kit or Bimini Sunshade.

**9** EVA Padded Standing Platform  
*Confidently stand and cast on the redesigned cockpit, complete with EVA pads and extra width for stability.\**

**10** Accessory H-Track Mounts  
Two H-Tracks provide infinite mounting options for your phone, Go-Pro and any items you need close.

**11** Accessible Tackle Storage  
*Two recesses with Bungee closures keep tackle boxes close.\**

**12** H-Bar Ready  
*Forward recesses provide precise placement for simple H-Bar setup.\**



**Fishfinder Ready**  
*Includes a transducer cavity and mounting plate for you to install a fishfinder.\**



**13** Power-Pole® Micro Mounting Pad  
*Molded in mounting surface to quickly install your Power-Pole Anchor System.\* Requires upgraded hatch.*

**14** Carrying Handles  
Provided at the bow and stern and two along the sides for easy handling and quick transport.

**15** Rod Caddies  
Keep rods within arm's reach and ready for your next cast.



Mirage Passport 12 shown

*\*Available on Mirage Passport 12 only.*



# MIRAGE COMPASS

## THE PERFECT COMBINATION: HIGH-PERFORMANCE MEETS HIGH-VALUE

Experience world-class fishing from the comfort of a brilliantly simple, high-performance and fully customizable platform. Designed from the water up, the Compass is a flexible kayak for kayakers and anglers of all abilities and experience levels.

The Mirage Compass' extra-wide, rock-steady 34" hull and standing deck provide unwavering stability for confidence and control. Ample cargo space and two molded-in rod holders offer quick and easy access to all your gear. Powered by the MirageDrive with Glide Technology, the Compass features all new Kick-Up Fins and push button cranks for easy height adjustments. The sleek bow design, retractable, spring-loaded rudder, and Tracking Skeg offer precise handling and tracking. Two H-Track accessory rails, plenty of storage space, and a built-in transducer cavity ready for fishfinder installation make the Mirage Compass the perfect all-around kayak for any water excursion.

For added stealth, upgrade to the Compass Camo package. Outfitted with the reversing MirageDrive 180 with Kick-Up Fins and a covert Camo color.



Available Colors:



POWERED BY  
MD GT



POWERED BY  
MD 180





# MIRAGE COMPASS DUO

## ONE KAYAK, TWO TIMES THE FUN

Searching for an elegantly simple yet highly customizable tandem kayak for on-water adventures with family, friends, and pets? Look no further than the Mirage Compass Duo. Powered by dual MirageDrives with Glide Technology and new Kick-Up Fins, the Duo's sleek hull design maximizes speed and stability, while greatly reducing drag. The cockpit features comfortable, ergonomic seating, 4 Integrated H-Tracks for accessory mounting, and abundant above and below deck storage compartments to house gear for two. The sleek waterline and Kick-Up Rudder system make for an impressively nimble tandem kayak that's easy to steer and extremely durable. The roomy Compass Duo is simple to use and adventure-ready, making it the ideal choice for water outings.



Available Colors:





# MIRAGE COMPASS

A PERFECT BALANCE OF FEATURES & VALUE MADE SIMPLE BY DESIGN

## 1 Powered by MirageDrive GT and Kick-Up Fins

The Glide Technology Drive features legendary, MirageDrive pedal performance. New Kick-Up Fins automatically retract upon impact.

*\*The Camo edition comes standard with the MirageDrive 180 with ARC Cranks.*

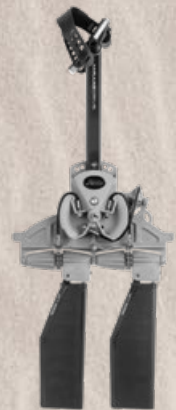

## 2 Optimal Seating Design

Constructed from breathable mesh fabric and adjustable for added comfort. Mounted at an ideal height for fishing, there's room for tackle storage underneath. Easily removable for use on shore.

## 3 Excellent Hull Performance

The durable polyethylene hull hits the sweet spot between tracking and maneuverability. The oversize cockpit includes plenty of flat deck area for standing.

## 4 Easy Steering System

When you want to paddle or head on shore, the spring-loaded rudder folds flush. Automatically kicks up if you hit something. Easy grip for fingertip steering.

## Lowrance Ready

Includes a transducer cavity for you to install a Lowrance fishfinder.

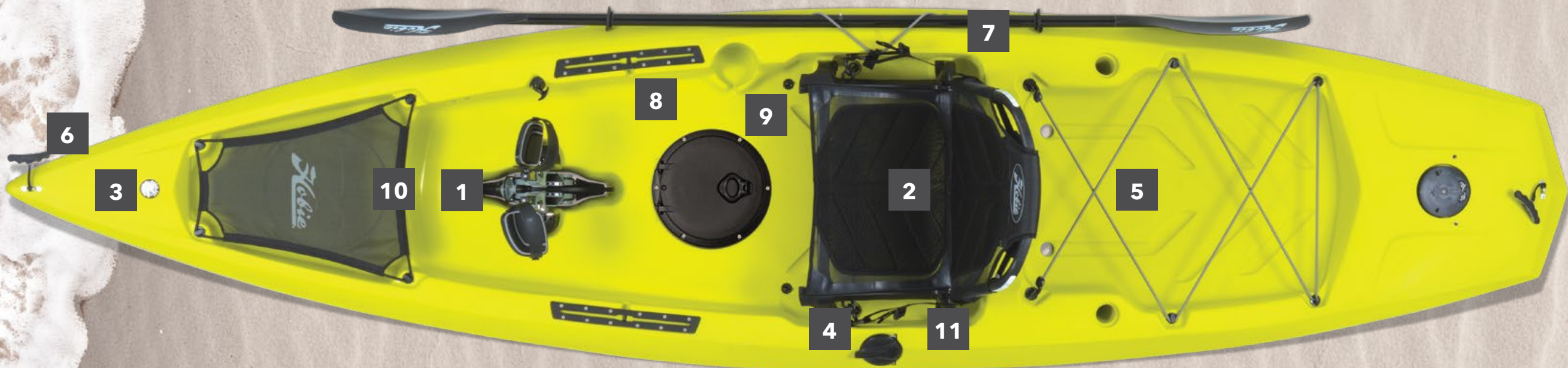

## 5 Storage Abounds

Plenty of storage for your gear, including an H-crate or Livewell, in the bow storage area, stern storage area with Bungee® tie-downs, and the 8-inch round Twist and Seal cockpit hatch.

## 7 Two-Piece Paddle

Negotiate surf-strewn beaches and rocky inlets with the included Two-Piece Paddle with Fiberglass Shaft.

## 8 Accessory Ready

H-Track accessory mounts provide no-drill customization.

## 10 Sail Mount

Ready for an optional Mirage Sail Kit.

## 6 Carrying Handles

Conveniently located midship, bow and stern.

## 9 Drink Holder

## 11 Side Carrying Handles

Improved for ease of loading and transport.







# MIRAGEDRIVE 180 A FORCE OF NATURE

*In 1997 Hobie permanently revolutionized kayaking with groundbreaking fin technology.*

*Experience 20 years of innovation perfected.*

The most significant technological innovation in modern kayak history, the MirageDrive, immediately revolutionized the sport of kayaking upon its introduction in 1997. Hobie has been innovating ever since. As the unquestioned leader in pedal-propulsion for over 20 years, more kayakers have purchased a Hobie than all other pedal brands combined.

With the patented MirageDrive 180 with all new Kick-Up Fins that automatically retract upon impact, Hobie has set a new standard for pedal drives. This award-winning fin technology delivers seamless adjustability, dependability, and full power in both forward and reverse. Best of all, it's completely beachable with the push of your pedal.

The MirageDrive 180 is featured on the Mirage Sport, Mirage Outback, Mirage Revolution® Series, Mirage Oasis®, Mirage Pro Angler Series, Mirage Island Series and Mirage Inflatable Series.

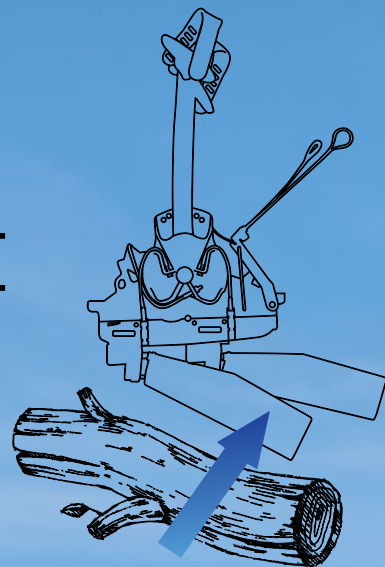

Kick-up Fins Retract When Impacting an Underwater Obstacle

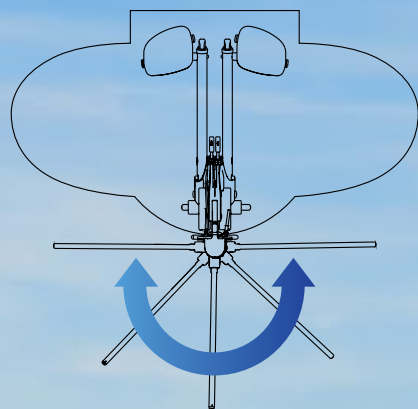

Fins May Flutter Closer To Hull For Shallows or Beaching

## THE DESIGN ADVANTAGE

### Revolutionary 180 Shifters

Instantly spin the fins from forward to reverse with a quick pull of the shifter cable. Unlike any other pedal system, the MirageDrive 180 produces full power in both directions.

### New for 2020: Kick-Up Fins

New Kick-Up technology provides the power to charge through the water as never before. Logs, kelp, shallows, rocks, no problem.

### Hands-Free Propulsion

Keep your fishing rod, camera, or cold drink where they belong - in your hands.

### Navigate Shallow Water

Fluttering the fins by using partial pedal strokes allows propulsion in very shallow water. Also, unlike propeller based pedal systems, the fins fold up flush with the hull for easy beaching.

### On-Water Debris

The natural back and forth motion of the fins shed debris and vegetation and won't twist up and get stuck like propeller drives.

### Strength and Durability

Built from the toughest components and designed to hold up to the harsh environments and underwater impacts, you won't find a tougher, better built drive.

### Glide Technology

Advanced roller bearings at key friction points reduce resistance for an ultra-smooth ride.

### The Click and Go System

Allows for quick and easy MirageDrive installation and removal.

### Easy Maintenance

A quick rinse with fresh water is all you need once you're done for the day.

### Height Adjustable

The ARC Cranks adjust effortlessly to fit kayakers of all sizes, from children to taller adults.





# Hobie VANTAGE SEATING



Vantage XT

*Unparalleled adjustability for the utmost comfort, a drier ride, and longer days on the water.*

The patented Vantage Seat maximizes on-water comfort, making for a luxurious ride so you stay focused on the environment around you. Our ergonomic Vantage Seats take adjustability and breathability to a new level, with features and materials that provide unrivaled support and comfort for a full day on the water.

All Vantage seats provide a kick stand for an even higher Vantage point and also double as beach chairs.

**Vantage ST and XT Seats: Pro Angler Series**  
The Vantage ST is equipped on the Mirage Pro Angler 12 and 14, while the XT come standard on the Mirage Pro Angler 17T. Integrated barrel adjusters easily customize the seat to the position that perfectly meets your angling needs. And for those times when the fish aren't biting, quickly recline to relax in total comfort.

**4**WAY  
ADJUSTABILITY



Vantage ST



Vantage CT



Vantage CTW

Designed for versatility, the bottom of the seat folds up quickly for extra room on the standing deck or raise the seat an additional five inches to enjoy the optimum Vantage position. The Vantage XT offers three extra inches of height than the ST model.

#### **Vantage CTW, CT, and CTi**

The CT is featured in all remaining rotomolded MirageDrive 180 kayaks (apart from the Outback, boasting the wider Vantage CTW seat with 1-1/2 extra inches for ultimate comfort).

Pull levers under your seat to quickly and easily adjust the seat's angle of recline and height.

The seat back is infinitely adjustable, capable of moving within a three-inch range so you can find your sweet spot.

The CTi comes standard in our Inflatable Series kayaks and boasts many of the same CT features.



# MIRAGE REVOLUTION SERIES

## WHEN SPEED MATTERS MOST

The Revolution Series showcases the true combination of speed and power. The Revos' sleek design makes them so fast and stable that no wave, wake, or wind can slow them down. The Revo 11 is an ideal mix of size, speed and maneuverability, easily transported to remote bodies of water. Of the three Revo models, the Revo 13 hits the sweet spot in terms of stability, speed, and tracking performance. Its 28.5" beam enhances stability and maximizes capacity without slowing you down, so you can hit the water with friends and always stay in the lead. The Revo 16 is the longest and fastest of the Revolution family. If you measure your days on the water by distance and speed, then the Revo 16 is the kayak for you. Every Revo comes outfitted with the industry-leading MirageDrive 180 with new Kick-Up Fins and ARC Cranks, a highly-adjustable Vantage CT seat, ample storage space, molded-in rod holders, and a Twist and Stow Rudder.

When it comes to the Revolution family, fast is an understatement.



Available Colors:



Revo 11

Revo 13

Revo 16







# MIRAGE SPORT & OASIS

## MIRAGE SPORT

Powerful, transportable, and agile define the Mirage Sport. At 9'7" from bow to stern, the Sport is an impressively compact platform smartly equipped with essential features like the patented MirageDrive 180 with Kick-Up Fins and ARC Cranks, the Twist and Stow Rudder for improved tracking and portability and two molded-in rod holders. At just over 60lbs, the Sport is the perfect fit for those seeking a lightweight kayak that is easy to car top and transport.

## MIRAGE OASIS

The Mirage Oasis is a spacious tandem kayak featuring a high-performance hull, fully loaded cockpit with highly-adjustable Vantage CT seating, three Twist and Seal hatches, and easy-access storage compartments. Dual MirageDrive 180s with new Kick-Up Fins and ARC Cranks power the Oasis to impressive speeds in forward and reverse. The Twist and Stow Rudder and dual steering capabilities provide enhanced tracking and maneuverability.



Available Colors:



Sport



Oasis





# SPORT, OASIS & REVOLUTION SERIES

## 1 MirageDrive 180 with Kick-Up Fins

Gets you where you're going with minimal effort. Hobie's hands-free, forward-reverse pedal system is tough and time-tested. New Kick-Up Fin technology swings back when impacted so nothing can slow you down.



## 2 Twist and Seal Hatch

With clever corkscrew closures and hinged lids, these hatches provide in-hull storage.

## 3 Vantage Seating

Seating doesn't come any more comfortable than the hyper-adjustable Vantage CT Seat.

## 4 Hookless Mesh-Covered Stowage Pockets & Drink Holder

Stash fishing tools, gloves, sunscreen or other items close at hand.

## 5 Rudder Control

The soft handle makes fingertip steering easy.



These Innovative Features Make Hobie MirageDrive 180 Kayaks And Fishing Boats World-Renowned



## 6 Carrying Handles

Provided bow and stern and on the sides, they make shore-side handling easier.

## 7 Covered Bow Hatch

Storage in spades, accessing the hull up front. Includes dual security bungees.

## 8 Two-Piece Paddle with Fiberglass Shaft

Navigate surf-strewn beaches and rocky inlets. Clips onto the hull when not needed.

## 9 Sail Mount

The Hobie exclusive Sail Mount stands ready for an optional Mirage Sail Kit.

## 10 Fishing Rod Holders

Two molded-in rod holders stand ready for action.

## 11 Cargo Area

The enormous Bungee covered Cargo Area has room for camping gear, tackle, or an optional H-Crate or Livewell.

## 12 Twist and Stow Rudder

Retracts onto the deck for beaching, storing or shallow running.



*Mirage Revolution 16 shown*



# MIRAGE OUTBACK: FISHING

## EXPERIENCE THE WORLD'S #1 PEDAL FISHING KAYAK

The best-selling Mirage Outback is a fully-loaded fishing machine, built for every conceivable fishing expedition. New for 2020, the MirageDrive 180 now comes standard with our patented Kick-Up Fins that automatically retract for easy access to the previously inaccessible. The extra-wide standing deck offers an improved casting platform and convenient vantage point for sight fishing, delivering superior vision from above while the revolutionary Guardian Transducer Shield gives you multidimensional vision below. The new Vantage CTW seat provides extra width for unmatched room and comfort. Four molded-in rod holders, multiple H-Track Deluxe mounts, and numerous high-capacity storage compartments ensure that all of your gear is at your fingertips. Outfitted with the MirageDrive 180 with Kick-Up Turbo Fins + ARC Cranks - now standard on all Outbacks - this fine-tuned angling vessel is highly versatile, fast, quiet, and exceedingly nimble. Featuring our Kick-Up Rudder system with dual steering capabilities, combating drift and navigating tight water has never been easier.



Available Colors:



POWERED BY  
MD 180



*Michelacomelli*





# MIRAGE OUTBACK: RECREATION

## MIRAGE OUTBACK REDEFINES KAYAK EXCELLENCE

The Mirage Outback is a feature-rich platform designed for comfort, speed, stability and extreme versatility. The sleek hull design is ultra-quiet and stable, providing a faster, smoother ride in any water condition.

The patented MirageDrive 180 with all new Kick-Up Turbo Fins + Arc Cranks powers the Outback to unrivaled speeds and provides pro-level performance in both forward and reverse. The 34" deck is perfect for standing and features the new, spacious Vantage CTW Seat, which is an extra 1-1/2 inches wide for unmatched comfort. Multiple high-capacity storage compartments, cargo hatches, and mesh pockets provide more stowage room than you have gear for. The H-Track Deluxe boasts a new retracting Bungee® system complete with 4 deck-side storage pockets so your gear is always secure and within reach.

*Shown at left with optional  
Sail Kit and Bimini sunshade.*





# MIRAGE OUTBACK

## THE NEW CLASSIC

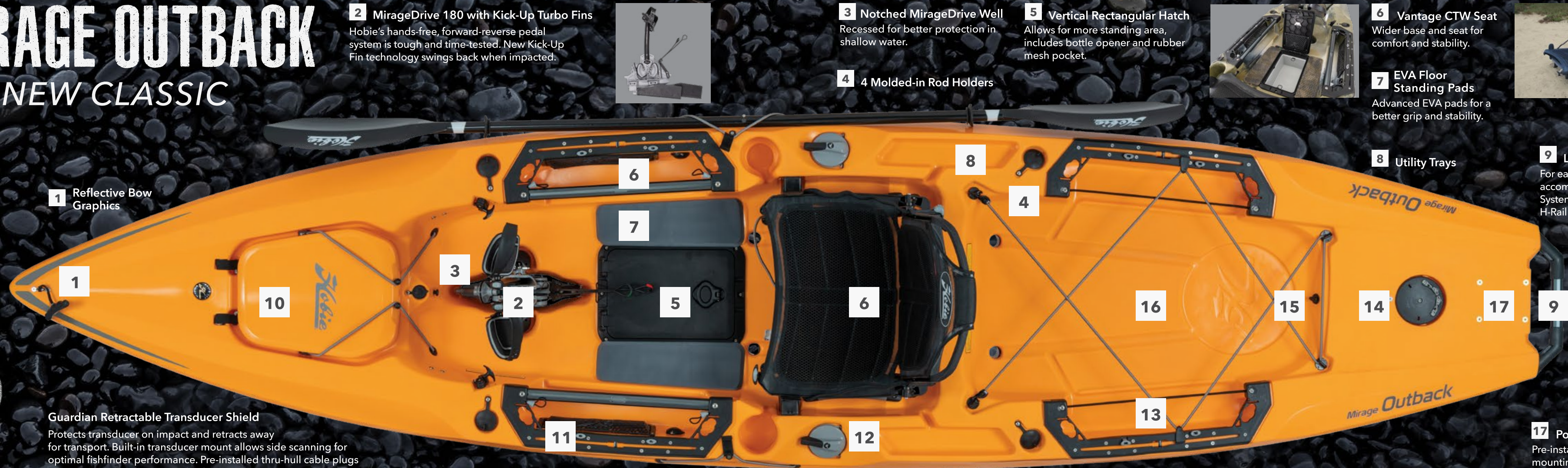

**1** Reflective Bow Graphics

**2** MirageDrive 180 with Kick-Up Turbo Fins  
Hobie's hands-free, forward-reverse pedal system is tough and time-tested. New Kick-Up Fin technology swings back when impacted.



**3** Notched MirageDrive Well  
Recessed for better protection in shallow water.

**5** Vertical Rectangular Hatch  
Allows for more standing area, includes bottle opener and rubber mesh pocket.



**6** Vantage CTW Seat  
Wider base and seat for comfort and stability.



**7** EVA Floor Standing Pads  
Advanced EVA pads for a better grip and stability.

**8** Utility Trays

**9** Large Rear Handle  
For ease of transport, accommodates Loader System and allows for H-Rail Accessory Mounts.

### Guardian Retractable Transducer Shield

Protects transducer on impact and retracts away for transport. Built-in transducer mount allows side scanning for optimal fishfinder performance. Pre-installed thru-hull cable plugs allow quick, no-drill, no-glue fishfinder installation.



**10** Front Hatch  
Ample storage includes dual security Bungees®.



**11** H-Track Deluxe w/ H-Rail Integrated Track  
Includes Side Accessory Tracks, Plier Holder, Knife Slot, Tackle Storage Retainers and an integrated leash retraction system.

**12** Dual Steering  
Easily control steering from both sides of the kayak.

**13** H-Track Deluxe w/ Bungee Tackle Retainer  
Includes Side Accessory Tracks, Plier Holder, Knife Slot, Tackle Storage Retainers and an integrated leash retraction system.

**14** Underhull Kick-Up Rudder  
Automatically kicks up when coming into contact with a solid object.

**15** Cart Keeper  
Bungee Locking System safely secures a kayak cart while on the water.

**16** Large Rear Cargo Well

**17** Power-Pole® Ready  
Pre-installed inserts to make mounting a Power-Pole a cinch, no mounting plate needed.





# MIRAGE PRO ANGLER 12

## THE MOST POWERFUL FISHING PLATFORM

Since their inception, Hobie's Pro Angler kayaks represent the ultimate fishing platform for professional anglers worldwide. For those who can tie knots in their sleep and catch bait fish with their bare hands, Pro Anglers deliver kayak fishing nirvana. The Pro Angler 12 comes fully loaded with high performance features, in a 12 foot platform.

Spacious and stable, the Pro Angler 12 allows for copious gear storage with a massive front hatch and spacious cargo area, horizontal rod holders, integrated tackle storage and Hobie H-Rail for mounting any accessory imaginable. The adjustable, Vantage ST seat provides an uber comfortable perch, while the massive deck with stain-resistant EVA padding makes fishing a cinch while standing. Equipped with the MirageDrive 180 with the revolutionary new Kick-Up Turbo Fins + ARC Cranks, the PA 12 comes with the proprietary Guardian Retractable Transducer Shield for unmatched speed, power, maneuverability, and stealth.

Available Colors:



Pro Angler 12







# MIRAGE PRO ANGLER 14

## THE ULTIMATE FISHING MACHINE

The PA 14 is the true flagship of Hobie's fishing fleet, dominating the water. For discerning anglers who demand it all - room, stability, performance, stealth, and comfort- the PA 14 stands alone. With maximum stability, precise tracking, loads of cargo space, and more features than we can list, this kayak is a bucket-list item for every die-hard angler. Its wide standing platform comes decked out with stain resistant and noise reducing EVA traction pads. The PA 14 features Hobie's award-winning MirageDrive 180 with new Kick-Up Turbo Fins + ARC Cranks, adjustable Vantage ST seat, dual steering, Guardian Retractable Transducer Shield and an extra-wide beam so you stay comfortable and confident when making tough casts from a standing position.



Available Colors:



Pro Angler 14



# MIRAGE PRO ANGLER 17T

The PA 17T is the ideal tandem fishing kayak for guides and anglers who enjoy hitting the water with a buddy. Multiple seating positions, including "social" where anglers can face each other, make this dynamic platform ideal for multi-person excursions. The cockpit comes equipped with comfortable Vantage XT seating, two MirageDrive 180 pedal systems with Kick-Up Turbo Fins + ARC Cranks, and a standing area with plenty of leg and elbow room for two. Multiple high-capacity storage compartments, cargo hatches, and mesh pockets are located above and below deck, offering tons of stowage room for all of your gear and tackle.

After over a decade, the PA 17 is still in a league of its own for those looking to share the ultimate fishing experience with family and friends.

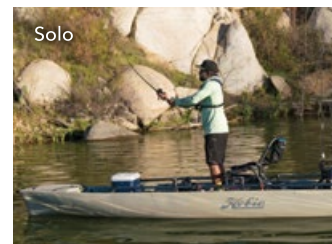

Available Color:



POWERED BY  
MD 180





# INTRODUCING MIRAGE 360

*ONLY HOBIE CAN DELIVER  
POWER IN EVERY DIRECTION*

Over 20 years ago, Hobie revolutionized kayak fishing with the introduction of the MirageDrive pedal system. Through constant innovation the MirageDrive has evolved over the years, continuing Hobie's dominance in the pedal kayak market. And now, the patented MirageDrive 360 that is taking the future of kayaking in a new direction - forward, backward, sideways and every degree in between. Anglers can navigate tight spaces, hold position, and fish with total control. With the all new Kick-Up Fins, you can access shallow and obstacle-filled waters with confidence.

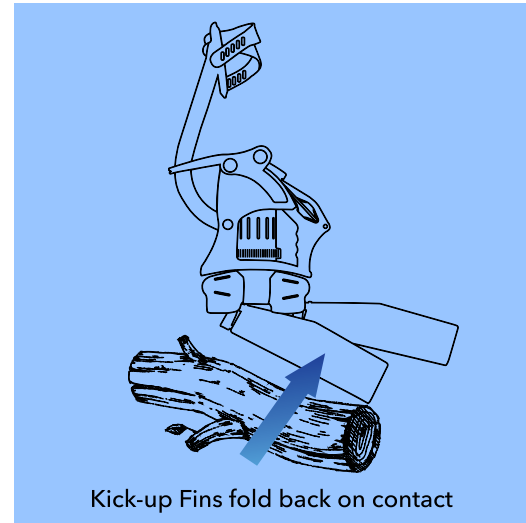

Kick-up Fins fold back on contact

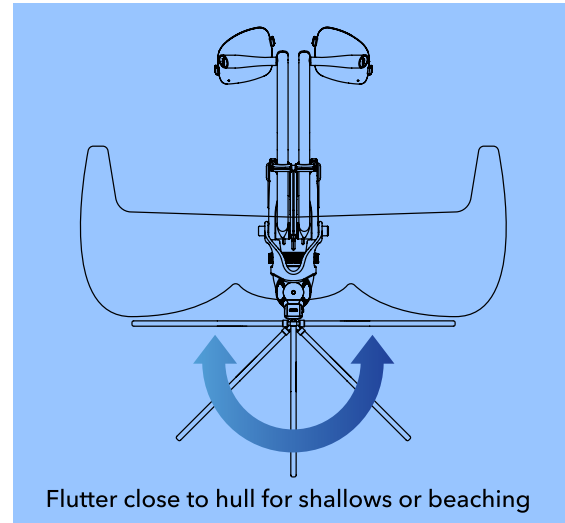

Flutter close to hull for shallows or beaching

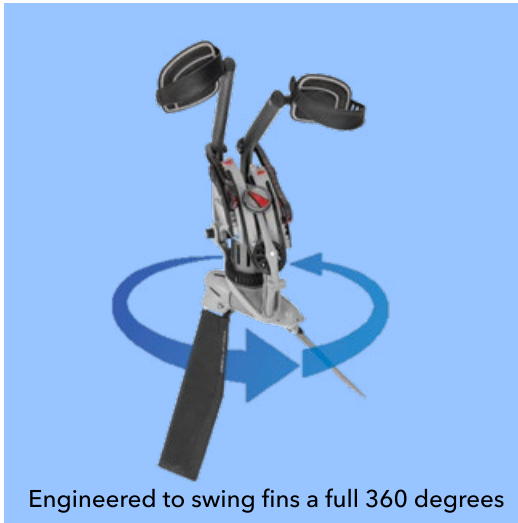

Engineered to swing fins a full 360 degrees

*THE 2020 PRO ANGLER 360 SERIES IS RUGGED  
AND RESPONSIVE, OFFERING 4-WHEEL DRIVE  
DURABILITY, PRECISE CONTROL AND THE ABILITY  
TO TURN ON A DIME.*







# MIRAGE PRO ANGLER



**FULL-CIRCLE  
POWER AND  
MANEUVERABILITY**

New for 2020, the Mirage Pro Angler 360 series fishing kayaks are as nimble as they are powerful, making it exciting to weave through obstacles and easy to stay on top of the fish. With all the fish features of the world's best-selling Hobie Mirage Pro Angler fishing kayaks, including six rod holders, the adjustable, elevated Vantage ST seat, extra wide hull, Guardian Transducer Shield and stain-resistant, noise reducing EVA padding, the Mirage Pro Angler 360 Series takes kayak fishing to an entirely new level. Kick-Up Fins make shallow and structure-filled areas far more manageable as they literally "kick-up" on impact. It's rock-steady platform delivers the ultimate in stability.

The 2020 Pro Angler 12 and 14 with 360 Drive Technology offers:

- Full 360 degrees of seamless mobility
- Exclusive Kick-Up Fin technology for chasing fish through the shallows. Access hard to reach honey holes by pedaling over logs and rocks
- Unrivaled boat control in any water condition imaginable
- New custom Arctic Blue Camo and Amazon Green Camo colors - both exclusive to the Pro Angler 360 Series

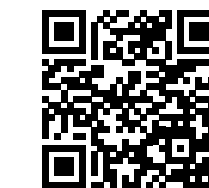

Scan code with smartphone camera for video link

Available Colors:

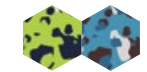

Pro Angler 12 360



Pro Angler 14 360



# THE ULTIMATE FISHING MACHINE

**1** **MirageDrive 180 Powered**  
Keep your fishing rod in your hands - with Hobie's forward-reverse pedal system with all new Kick-Up Flns. Pro Angler 360 Series offers the MirageDrive 360.

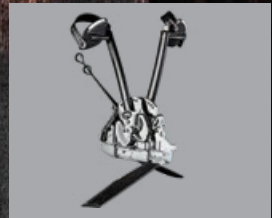

**2** **Vantage Seating**  
Take comfort to a new level with back, bottom, and BOA®-set lumbar support. Vantage Seating is removable to use on shore.

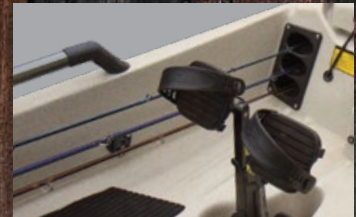

**3** **Horizontal Rod Storage**  
**4** **Rudder Control**  
The soft handle makes fingertip steering easy.

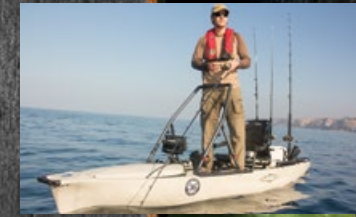

**H-Bar**  
The optional H-Bar is a sturdy leaning post and grab rail for stand-up fishing. Compatible with H-Rail accessories.

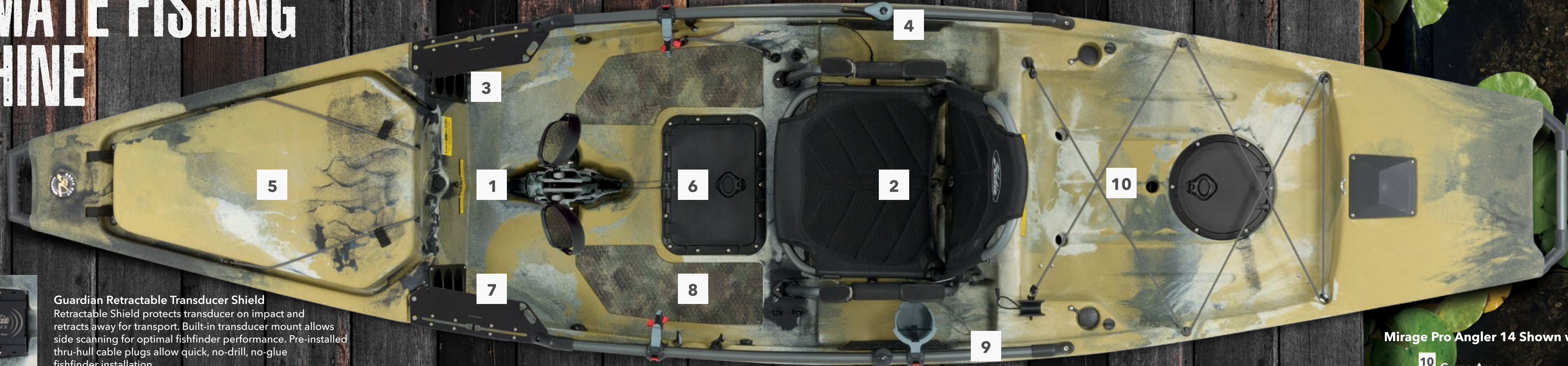

**Guardian Retractable Transducer Shield**  
Retractable Shield protects transducer on impact and retracts away for transport. Built-in transducer mount allows side scanning for optimal fishfinder performance. Pre-installed thru-hull cable plugs allow quick, no-drill, no-glue fishfinder installation.



**5** **Large Front Hatch with Removable Liner**  
Stash extra gear - there's plenty of room.

**6** **Pivoting Tackle Management System**  
Slide your tackle trays right into the PA series with ease.



**7** **Mounting Boards**  
Features an integrated track system, gear tie-down points, plier holder and knife slot.

**8** **Standing Platform Deck Pads**



**9** **H-Rail**  
There's no need to drill holes when rigging a Pro Angler. Twelve-sided Hobie H-Rail bars hold a variety of accessories including Tackle Bins, Rod Racks, Cup Holders, Rod Holders and Mounting Plates.



**Mirage Pro Angler 14 Shown with MD 180**

**10** **Cargo Area**  
There's room for an optional H-Crate, Livewell or whatever else you need to tote. A pair of nearby vertical rod holders are ideally angled for trolling.

**Skeg**  
Deploy the tracking skeg for improved course keeping. Retract for maneuverability.





# MIRAGE INFLATABLE SERIES

## CONVENIENCE & PERFORMANCE

Hobie's Inflatable kayaks are portable, lightweight, and durable; striking the perfect balance between superior performance and portability.

The i9, the most compact of the Inflatable series, makes an ideal recreational craft for those with very limited storage space. The i11 is versatile - an excellent choice for people who appreciate the perks of an inflatable, yet still want all the capabilities of a high-performance fishing platform. Spacious and stable, the i12 is the ultimate single-person recreational inflatable offering even more speed and storage than the i9. Hobie designed the i14T: a high-performance inflatable kayak built for two that strikes the perfect balance of stability and speed.

Each Inflatable Series kayak features the MirageDrive 180 with Kick-Up Fins + ARC Cranks, Vantage CTi seating with loads of adjustability and lumbar support, travel bag with portable hand pump, and drop-stitch flooring for high-pressure inflation, rugged durability, and structural rigidity.

*Moss / Smoke color only available on the i11S*

Available Colors:





# MIRAGE INFLATABLE SERIES

CONVENIENCE, PORTABILITY & A GREAT RIDE

**1** MirageDrive 180 Powered  
Intuitive and efficient, Hobie's MirageDrive 180 with new Kick-Up Fin technology shifts propulsion from forward to reverse on a whim.

**2** 1000 Denier PVC Hull  
Built tough for years of fun.

**3** Vantage CTi Seating  
State-of-the-art seating offers multiple points of adjustment and the comfort of breathable mesh. It can even be used as a beach chair.

**4** Drop Stitch Floor  
This method of construction allows for much higher inflation pressures. Thousands of tiny threads connect the top and bottom layers of the floor, providing remarkable structural rigidity and increased performance.



*111S shown*

**5** Carrying Handles  
With handles forward, aft and amidships, portaging is easier and more comfortable.

**6** Four-Piece Aluminum Paddle

**7** Rudder Control  
Steer with your fingertips. The soft handle of the Rudder Control can be mounted on either side of the seat.

**8** Locking Valves  
Valves lock into the pump for easier inflation and lock into open position for quick deflation.

**9** Cargo Areas  
The front and rear Cargo Areas with Bungee tie-downs ensure gear is still there when you get to camp.

**10** Twist and Stow Rudder  
Engage or disengage the retractable rudder system by pulling one of the T-shaped control handles.

**All Inflatable Kits Include:**  
An Easy-Load Rolling Travel Bag that allows easy transportation and storage of the folded-up kayak, Cup Holders, and a high capacity piston Hand Pump.

**Optional Accessories**  
Options include a Plug-in Cart for transportation, adhesive iAccessory Mounts, Rod Holders, and other fittings. See our Parts and Accessories Catalog for more.





# MIRAGE ISLAND SERIES

## TIMELESS DESIGN & HOBIE INNOVATION

Often praised as the best sailboat available, the Mirage Island Series offers a unique way to sail by combining the power of the pedal with the force of the wind. Designed for superior speed and performance, the Islands deliver the most exciting on-water experience imaginable from an approachable, easy-to-learn platform. Built for sailors of any size and experience level, they offer an unmatched experience for those seeking fun family outings as well as adventurers looking to push the limits of man and craft.

Available in both single and tandem versions, these sailboats are simple to launch and beach, making it easy to get started but hard to want to stop.

### 1 Roller Furling Boomless Mainsails

Providing a powerful yet user-friendly ride, the sail wraps easily around the carbon composite mast, making it simple to unfurl, trim and furl in all conditions.

### 2 Island Rudder

The oversized rudder makes steering effortless and precise, enabling maximum maneuverability.

### 3 Kick-Up Centerboard

The Kick-Up Centerboard is fully retractable and improves tracking performance while under sail.

### 4 MirageDrive 180 w/ ARC Cranks + Kick-Up Turbo Fins

Outfitted with the MirageDrive 180, the Island Series is truly adventure-ready, offering unrivaled power in both forward and reverse.

### 5 Aka Crossbars

The crossbars pivot back against the hull for easy transportation, docking and storage, or to help land a prized catch.

### 6 Ama Outriggers

The durable Ama Outriggers provide the Islands with confidence-inspiring stability.



Available Colors:



POWERED BY  
MD 180

Find Your Local Island Club: [hobie.com/hobieislandclub](http://hobie.com/hobieislandclub)





# PADDLE KAYAKS

## LANAI

The Hobie Lanai is a lightweight, easy to use paddle kayak with performance-grade features for a faster, smoother ride. The 9' waterline and 30" beam is as stable as it is fast, so you feel in complete control on any adventure. At 50 lbs. fully rigged, it's lightweight and transportable making it perfect for smaller paddlers, yet adjustable to accommodate taller users.

## QUEST

The Quest 13 is Hobie's swift and powerful, performance paddle kayak. Nimble and quiet, the Quest 13 comes standard with the comfortable Vantage CT seat and adjustable foot braces, but kicks it up a notch in speed, tracking, and cargo space.

## KONA & ODYSSEY

The Kona is Hobie's ultimate crossover tandem paddle kayak designed for one or two riders and endless adventures. The molded center seat and extra-wide beam keep the Kona responsive and stable in all conditions. The Odyssey is a sleek and powerful tandem kayak capable of superior speeds and tracking performance. Both tandems feature adjustable padded seating, two Twist and Seal hatches, and mesh stowage pockets for keeping your essential items within reach.

	LANAI	QUEST	KONA	ODYSSEY
CREW	Single	Single	Tandem	Tandem
LENGTH	9' / 2.74 m	13' / 3.96 m	11' 6" / 3.51 m	14' / 4.27 m
WIDTH	30" / 0.76 m	28.5" / 0.72 m	34" / 0.86 m	33" / 0.84 m
CAPACITY	250 lbs. / 113 kg #	350 lbs. / 159 kg #	425 lbs. / 193 kg #	550 lbs. / 249 kg #
FITTED HULL WEIGHT	46 lbs. / 21 kg	65.5 lbs. / 30 kg	68 lbs. / 31 kg	81.5 lbs. / 37 kg
FULLY RIGGED WEIGHT	50.5 lbs. / 23 kg	70.5 lbs. / 32 kg	78 lbs. / 35 kg	91.5 lbs. / 42 kg



**BUILT TO LAST  
FOR FAMILY FUN ON THE WATER**

Available Colors:



Lanai Quest Kona Odyssey



# ACCESSORIES

For More Kayaking Parts & Accessories Visit [hobie.com](http://hobie.com)



## Hook2 7 TripleShot

Pairing the wide-angle Broadband Sounder™, High CHIRP and DownScan Imaging™ with built-in mapping, TripleShot gives you all that, PLUS SideScan imaging for scanning large areas around you. Track baits, mark fish and identify structure under and around your kayak. The Hook2 7 TripleShot will help narrow your search for productive features like ledges, points or drop-offs with a bird's eye view of 1-foot contours on more than 3,000 lakes.

72020211 HOOK2 7 TripleShot

72023055 COMPATIBLE FF MOUNT RAM 1.5" for HDS

## H-Crate

Hobie's H-Crates keep your tackle and other gear organized in one easy-to-reach space. Both models of the H-Crate are easily removable, incorporate four vertical rod holders with bungee retainers, and integrate H-Rail carrying handles that double as a mounting platform. For the ultimate experience add a soft cover, additional vertical rod holders or any H-Rail accessory in our line to your H-Crate or H-Crate Jr.

72020088 H-CRATE

72020097 H-CRATE SOFT COVER

72020298 H-CRATE JR.

72020297 H-CRATE JR. SOFT COVER

72020015 ADDITIONAL ROD HOLDER

## Inflatable PFD

Light weight and comfortable. Ready when you need it, manual CO2 inflation or by mouth inflator allows for swimming, wading and intentional immersion. Available in Blue, Red, Green/Hobie fish pattern, Tan/Hobie fish pattern.

S6782BL BLUE

S6782GR GREEN

S6782RD RED

S6782TN TAN

S6779R PFD INFLATABLE REARM KIT

Note: Air Shipping Restrictions Co2 / Dangerous Goods

## Mirage Sail Kit

Comes with two-piece mast, a 20.25 ft2 sail, lines, fittings and a storage bag.

84512002 RED/SILVER

84514002 ORANGE/PAPAYA

84513002 SILVER/CHARTREUSE

84515002 CHARTREUSE/AQUA

84516002 NOT AVAILABLE FOR INFLATABLE 11

PAPAYA/WHITE



## Hobie Bimini

Relax all day under the cool shade of our all new kayak Bimini. UPF 50+ fabric and sophisticated articulation feature provide sun and rain protection no matter the time of day. Made with water-resistant and lightweight ripstop nylon is rugged and durable.

72020520 HOBIE BIMINI POSEIDON BLUE

72020521 HOBIE BIMINI MARINE GRAY



## Livewell V2

The newly redesigned Hobie Livewell sports a fresh color scheme, modern lines and more built-in features than ever before. This livewell is plug-and-play with most Hobie kayaks and includes: (1) 6V sealed gel cell battery + charger for powering the pump, an adjustable downspout for filling the tank half way, a corrosion resistant power switch, 3 integrated rod holders, a threaded drain plug, easily removable tank partitions for keeping bait healthy, an 8" Twist and Seal hatch for access and bait concealment, heavy-duty straps for attaching it to the kayak and a carrying handle for easy transport.

72020077 LIVEWELL V2

72020015 ADDITIONAL ROD HOLDER



## Vantage Seat Accessory Bag

The Vantage Seat Accessory Bag is the perfect addition to your MirageDrive kayak. Ideal for storing extra tackle, keys and wallet, lunch, a foul weather jacket, birding glasses, safety gear and more.

Dimensions: Approx. 8" Tall x 8" Wide x 3" Deep.

72020117 VANTAGE SEAT ACCESSORY BAG



## Fold and Stow Cart

Fold and Stow cart weighs in at 5 pounds, functions well on solid to semi-soft surfaces, and conveniently breaks down to stow inside the bow hatch of any rotomolded Hobie kayak equipped with the large front cargo hatch.

80047001 FOLD AND STOW CART

FIXED FRAME CARTS ALSO AVAILABLE:

80045001 STANDARD CART

80046001 HEAVY DUTY CART

80044101 TRAX 2 CART

80043001 TRAX 2-30

# ACCESSORIES



## Hobie Thin-Back Life Vest

Features a thin foam back design... perfect for use with Hobie Vantage seats. This thinner back profile provides more mobility and comfort, while reducing interference with taller seat backs.

S6104XX (XX = SIZE) MENS SLATE

S6107XX (XX = SIZE) MENS FISH SLATE GREEN

S6105XX (XX = SIZE) WOMEN'S SUN

S6106XX (XX = SIZE) WOMEN'S SLATE



## Adjustable H-Bar

Standing support for kayaks! The adjustable H-Bar integrates with all H-Rail accessories for easy customization. It folds up when you need it and away when you don't. The aluminum extrusion is strong and lightweight for leaning against or holding on to while entering/exiting the boat or pulling yourself up from a seated to a standing position. Fully adjustable to fit a wide variety of kayaks.

84500115 PA17 H -RAIL ADAPTER KIT

84500116 H-BAR FOR PRO ANGLER

84500117 H-BAR FOR COMPASS

84500119 H-BAR PRE-2019 OUTBACK/UNIVERSAL

84500120 H-BAR FOR OUTBACK 2019+



## Tie-Down Straps

Rack tie-down straps, made of durable black polypropylene webbing. Diagonal cut and ironed ends make threading ends into buckles easier.

72042001 TIE DOWNS 12' (PAIR)

72043001 TIE DOWNS 15' (PAIR)



## Gerber Fishing Tools

Some fishermen are content to stick to the beaten path. Others can't leave it soon enough. The Fish collection is built for the latter, with an innovative lineup of fishing gear that is purpose-built for the adventure.

72026010 MAGNIPLIER™

72026013 NEAT FREAK™



## Fish Bag/Soft Cooler

Keep your food or catch cold all day, even in very hot conditions. High quality construction includes half-inch closed cell foam that insulates, vinyl coated polyester that's durable and YKK zippers that are strong. Has handles for carrying and d-rings on the sides for attaching to the kayak. Design features for storing additional gear on all bag sizes.

72020118 COOLER / FISH BAG - XL

72020111 COOLER / FISH BAG - LARGE

72020113 COOLER / FISH BAG - MEDIUM

72020114 COOLER / FISH BAG - COMPASS



## EVA Deck Pad Kits

Hobie's EVA deck pad kits are custom fit to every curve of your kayak and deliver supreme comfort, traction and sound dampening qualities.

72020250 PA14 GREEN/ESPRESSO

72020251 PA14 TITANIUM/BLUE

72020252 PA14 GREY/CHARCOAL

72020253 PA12 GREEN/ESPRESSO

72020254 PA12 TITANIUM/BLUE

72020255 PA12 GREY/CHARCOAL

72020261 2019 OUTBACK TITANIUM/AEGAN BLUE

72020264 2019 OUTBACK 2019 GREEN/ESPRESSO

72020267 2019 OUTBACK GREY/CHARCOAL



## Power-Pole® Micro Anchor and Spike

Fast and secure anchoring for Hobie Pro Angler or Outback. Includes Micro Driver Unit and and new 8' UL Spike.. This all-electric unit is extremely quiet and easy to use. It works with a 3/4" spike to stop and anchor your kayak at the push of a button. It functions as a conventional stakeout pole or shallow water anchor without having to manually deploy it. With Power-Pole's signature strong hold, the Micro gives you a smooth stop in seconds.

72020083 POWER-POLE MICRO AND SPIKE

(Pro Angler series and pre-2019 Outback requires mounting kits to properly distribute loads. Not approved for use on other Hobie models at this time)



## MirageDrive Stow Bag

Protect your MirageDrive...and other goods in your car from the Drive! This heavy-duty Cordura and mesh bag fits the complete MirageDrive with standard fins or the ST Turbo length.

80024 MIRAGEDRIVE BAG



# THE MIRAGE FLEET



## MIRAGE KAYAKS

PASSPORT 10.5    PASSPORT 12    COMPASS    COMPASS DUO    OUTBACK    REVOLUTION 11    REVOLUTION 13    REVOLUTION 16    SPORT    OASIS



## MIRAGE INFLATABLES

INFLATABLE 9    INFLATABLE 11    INFLATABLE 12    INFLATABLE 14

## MIRAGE PRO ANGLERS

PRO ANGLER 12    PRO ANGLER 14    PRO ANGLER 17T    PRO ANGLER 12 360    PRO ANGLER 14 360

## MIRAGE ISLANDS

ADVENTURE ISLAND    TANDEM ISLAND

CREW	Single	Single	Single	Tandem	Single	Single	Single	Single	Single	Tandem	Single	Single	Single	Tandem	Single	Single	Tandem	Single	Single	Single	Tandem
LENGTH	10'6" / 3.2 m	12' / 3.66 m	12' / 3.66 m	13' 5" / 4.11 m	12' 9" / 3.89 m	11' 6" / 3.51 m	13' 5" / 4.09 m	16' / 4.88 m	9' 7" / 2.92 m	14' 6" / 4.42 m	9' / 2.74 m	11' 3" / 3.4 m	12' / 3.66 m	14' / 4.3 m	12' / 3.66 m	13' 8" / 4.17 m	17' / 5.18 m	12' / 3.66 m	13' 8" / 4.17 m	16' 7" / 5.05 m	18' 6" / 5.64 m
WIDTH	34" / 0.86 m	34" / 0.86 m	34" / 0.86 m	35" / 0.88 m	34" / 0.86 m	29" / 0.74 m	28.5" / 0.72 m	27.5" / 0.7 m	29.5" / 0.75 m	33" / 0.84 m	36" / 0.91 m	39" / 1 m	36" / 0.91 m	36" / 0.91 m	36" / 0.91 m	38" / 0.97 m	43.5" / 1.1 m	36" / 0.91 m	38" / 0.97 m	w/ Amas Out: 9' 6" / 2.90 m w/ Amas In: 44" / 1.12 m	w/ Amas Out: 10' / 3.05 m w/ Amas In: 4' / 1.22 m
CAPACITY	325 lbs. / 147.42 kg #	400 lbs. / 181 kg #	400 lbs. / 181 kg #	475 lbs. / 215.5 kg #	425 lbs. / 192.78 kg #	275 lbs. / 125 kg #	350 lbs. / 159 kg #	350 lbs. / 159 kg #	225 lbs. / 102 kg #	550 lbs. / 249 kg # *	325 lbs. / 147 kg	400 lbs. / 181.4 kg	500 lbs. / 227 kg	550 lbs. / 249 kg	500 lbs. / 227 kg #	600 lbs. / 272 kg #	900 lbs. / 408 kg #	500 lbs. / 227 kg #	600 lbs. / 272 kg #	400 lbs. / 181.44 kg #	600 lbs. / 272 kg #
FITTED HULL WEIGHT	65 lbs. / 29.48 kg	73 lbs. / 33.1 kg	68 lbs. / 31 kg	92 lbs. / 41.7 kg	85 lbs. / 38.56 kg	64 lbs. / 29 kg	70.5 lbs. / 32 kg	75.5 lbs. / 34 kg	61 lbs. / 28 kg	93 lbs. / 42 kg	41 lbs. / 18.6 kg	35.5 lbs. / 16.1 kg	53.5 lbs. / 24.3 kg	67.1 lbs. / 30.4 kg	105 lbs. / 48 kg	120.5 lbs. / 55 kg	206.5 lbs. / 94 kg	109.5 lbs. / 49.7 kg	124.5 lbs. / 56.5 kg	102 lbs. / 46 kg	130 lbs. / 59 kg
FULLY RIGGED WEIGHT	75 lbs. / 34.02 kg	83 lbs. / 37.6 kg	87 lbs. / 39 kg	127 lbs. / 57.6 kg	103 lbs. / 46.72 kg	81 lbs. / 37 kg	88 lbs. / 40 kg	92 lbs. / 42 kg	78 lbs. / 35 kg	127 lbs. / 58 kg	70 lbs. / 31.8 kg	64.5 lbs. / 29.3 kg	82.4 lbs. / 37.4 kg	111.4 lbs. / 50.6 kg	128.5 lbs. / 58 kg	144.5 lbs. / 66 kg	244 lbs. / 111 kg	132.5 lbs. / 60.1 kg	148.5 lbs. / 67.4 kg	185 lbs. / 84 kg	240 lbs. / 109 kg

### COLORS



### COLORS



### NOTES

Fitted Hull Weight: Includes all permanently-attached standard features (e.g., hatches, handles, rudder, hardware).

Fully Rigged Weight: Includes the Fitted Hull Weight, plus all other standard features that are removable, e.g. MirageDrive, seat, paddles, gear bucket, cassette plug, Pro Anglers (removable liner), Islands (sail, amas, akas, daggerboard), Inflatables (travel bag, pump, repair kit).

# Meets NMMA (National Marine Manufacturers Association) certification for flotation.

\* See website for info on load distribution

All colors, graphics and specifications of all models are subject to change without notice.

Published boat dimensions are estimated and may deviate slightly due to unavoidable manufacturing variables.



# Hobie

**HOBIE COMPANY**  
Holding Company  
Oceanside, CA, U.S.A.  
1-800-HOBIE-49  
hobie.com

**HOBIE AUSTRALASIA**  
Subsidiary  
Huskisson, NSW, Australia  
1-800-4-HOBIE  
hobie.com

**HOBIE EUROPE**  
Subsidiary  
Toulon, France  
+33 (0) 494 08 78 78  
hobie.com

**HOBIE KAYAK EUROPE**  
Independent Distributor  
Stellendam, The Netherlands  
+31 (0) 187 499 440  
hobie.com

**HOBIE BRASIL**  
Independent Distributor  
Porto Belo, Santa Catarina, Brasil  
+55 (47) 3369 6096  
hobie.com



87369358